



**FUNCTION.  
UTILITY.  
VERSATILITY.  
FARAN.**



**Dom Thomas**  
Co Founder and Bike Designer

At Fairlight we are constantly evolving and improving our designs, driven by the belief that we want our customers to receive the best possible product from their purchase. It's a satisfying feeling to know you are shipping products where you have put tremendous care, consideration and learnings into their design and manufacture. Fundamental to this belief is the idea that beyond words and marketing, the products can only speak for themselves. Quality and thoughtfulness can be perceived, you don't need to know what you are looking at or how it has been made, but you can sense when it has been designed and built with care and consideration. When you open the box and see the details such as the heavily shaped tubes, the hand-ground dropout fillets, or the CNC'd dropout inserts, I am confident you will sense a level of attentiveness that goes way beyond a basic functional need. We use scale and mass production methods to offer genuine improvements to the customer, this means the creation of custom tooling as well as significant time spent on exploratory design work.

The Faran 2.5 features subtle but authentic refinements, such as the addition of a heat-treated rear triangle which has allowed us to remove 0.15mm wall thickness from the chain stays; resulting in reduced weight and increased compliance. The v2.5 also sees the inclusion of the Fairlight x Bentley Mk II dropouts which feature beautifully CNC machined fully modular inserts on both sides.

The Faran is without doubt the most versatile model we make, it's a bike that will continually evolve to reflect your riding style and it will become a tool that you rely on and grow attached to.

*Dom Thomas*

## Faran - Concept

The Faran is all about utility and versatility; road plus, commuting, gravel rides, audax, randonneuring with a small front rack, or touring with front panniers. It is the sort of bike that you will become very attached to as you rack up the miles together. As the seasons and years pass, racks and cages will be bolted on or taken off, wheels & tyre sizes will be experimented with; it's form, capability and loading capacity will evolve to reflect your riding style. On some level every cyclist has the desire for self-sufficiency and escape and it's this idea which drives the utilitarian design ethos of the Faran.

The steel fork is a 'commitment to utility' and it has mounts for every rack and cage set-up you can imagine. Some folks just love the ride quality of a steel fork and rightly so. The low-mid trail geometry (more on that later in the document) means it handles well with a front load such as a rando bag and/or panniers, but ride it unloaded and it feels agile and precise [think Strael handling but with big tyres] so it's perfect for a 'road plus' build. The seat tube length is similar to the Strael, so less compact than the Secan; that means more room for frame bags and more of a flat-ish top tube aesthetic. The Faran benefits from all the tubing technology developed for the Secan, but the 'non-heat treated' Reynolds 631 material (vs. heat treated 853), combined with the steel fork results in a lower price. We think it is fantastic, thoughtfully considered product, and the most versatile frameset we make.

## New on the Faran 2.5

- Clearance for 650x60mm (width as measured) tyres.
- New 0.8mm heat-treated chainstays.
- New 0.8mm heat-treated seatstays.
- New Bentley x Fairlight Mk.2 dropouts. Featuring fully replaceable drive side and disc side CNC inserts.
- New size specific top tube and seat stays for 61R and 61T sizes. Designed for bigger, stronger riders.



## FARAN 2.5 - Tech & Specs overview

### Place of Manufacture:

- Handmade in Taiwan.

### Dimensions:

- Bottom bracket - BSA 68mm.
- Seat clamp - 29.8mm or 30.0mm.
- Seat post - 27.2mm.
- Front derailleur band - 28.6mm
- Headset specification - EC34/28.6 EC34/30
- Rear Axle/hub standard - 142x12mm.
- Axle length - 168mm x 12mm with 1.5mm pitch.

### Brake/dropout Standards:

- Flat mount 140mm direct.
- Max 160mm rear rotor.
- Replaceable derailleur hanger.

### Tyre Clearances:

- 1x - 650x60 or 700x50
- 1x with fenders - 650x55 or 700x45
- 2x - 650x57 or 700x47
- 1x with fenders - 650x48 or 700x42

### Chainset:

- Single ring - 44T max ring.
- Double ring - 50-34T max.
- Triple ring - chainline dependent. email for info

### Fork:

- Axle to crown - 408mm
- Rake - 60mm
- Tyre clearance - same as Faran 2.5 frame
- Axle length - 168mm x 12mm with 1.5mm pitch.
- Internal dynamo routing.

### Cages & Racks - Frame:

- 3 x sets of bottle mounts.
- Rear rack mounts.
- Mudguard mounts.

### Cages & Racks - Fork:

- 4 x angled bosses each leg.
- Mid leg lowrider mounts.
- Rando rack bosses.
- Mudguard mounts.

### Gearing & Wiring:

- External cable routing.
- 1x and 2x guide options.
- Di2 compatible.
- Rear dynamo lighting compatible.

### Torque Settings:

- Brake mount - 8Nm.
- Axles - 12Nm.
- Derailleur hanger - 2Nm.
- For components please refer to manufacturers guidelines.

### Weight:

- Frame - painted 54T frame - without bolts, axle or brake mount = 1,968g
- Frame - Bolts, rear axle, brake mount, derailleur hanger & brass plates = 208g
- Fork - painted - without bolts or axle = 1,205g
- Fork - Bolts & axle = 77g

### Weight Limits:

- Rider weight limit = 125Kg
- Combined max luggage = 25Kg
- Max Fork = 15Kg
- Rear rack = 25Kg





















# TUBING



### **Reynolds 631 Top Tube - Custom for Fairlight**

631 - 25.4mm - 25/30 oval - 0.8/0.5/0.8

The tube starts life as a 25.4mm round tube and is fully ovalized to 20 x 30mm. This tube is critical in providing the excellent comfort of our frames. The stiffness in the horizontal plane is equivalent to that of a 30mm tube, while the narrow 20mm tube in the vertical plane means it provides excellent comfort, effectively flexing as the wheels try to move away from each other under load. A more standard round 28.6mm or 31.8mm top tube would be torsionally (twisting forces) stiffer, but we design the downtube and top tube to work together in how they deal with the various loads/forces. The tube is butted at 0.8/0.5/0.8.

### **SIZE 61R & 61T**

### **Reynolds 631 Top Tube - Custom for Fairlight**

631 - 28.6mm - 25/32 oval - 0.8/0.5/0.8

On the 61's we use a 28.6mm tube formed into a 25 x 32mm oval.





### Reynolds 631 DZB Down Tube - Custom for Fairlight

631 DZB - 34.9mm - 30/40 opposed oval - 1.0/0.8/0.5/0.8 - with gusset

The tube starts life as 34.9mm round tube but is ovalized at both ends to become 30 x 40mm. The ovals oppose each other; the 40mm horizontal oval at the BB shell adds lateral stiffness, where as the vertical 40mm vertical oval at the headtube resists the braking and ground forces from the most highly stressed area of the bike. In the case of the Faran [with a standard 36mm headtube] the vertical oval also gives the strongest weld.

The tube has double zonal butting, which means an extra butt at the headtube end for strength. The butt profile is 1.0/0.8/0.5/0.8. We use a small gusset at the head tube end to provide extra strength for heavy front loading.



### **Reynolds 853 Seat Tube**

853 - 28.6mm/29.8mm - 0.9/0.6/1.2

We use a standard butted seat tube designed for a 27.2mm seat post. The majority of the tube is 28.6mm in diameter, where as the top section is externally butted to 29.8mm to give the correct inner dimension for the seat post and to provide extra surface area for the top tube and seat stay welds. The tube is butted 0.9/0.6/1.2.

### **68mm BSA BB Shell**

Tried, tested, proven. We are huge advocates of the standard 68mm threaded BB shell.



## 4130 CHROMOLY

### 4130 Machined and Relieved Head Tube

The headtube is 37mm in diameter but relieved down to 36.25mm, apart from at the ends where it remains at 37mm to provide sufficient wall thickness for fitting of the headset cups. The internal measurement is 33.95mm and is designed to accept a 1.1/8" steerer tube with a standard external cup headset. For this reason, the frame is not compatible with tapered steerer forks and is designed to be used with our matching steel fork. A 1.1/8" (28.6mm) steel steerer tube with good wall thickness is plenty stiff enough. There has been a trend recently for steel forks with tapered steerer tubes but they are incredibly heavy and overbuilt in our opinion. We would only consider one on a dedicated mountain bike where the fork was replacing a longish travel suspension fork (therefore a long axle to crown length) to provide a lot of load carrying capacity.





### 14mm 4130 Non-Taper Seat Stays - Custom Shaped

4130 heat treated - 14mm No Taper - 0.8mm wall.

This is the same diameter seat stay that we use on all other Fairlight models and along with the top tube and chainstays is an important part of the ride quality of our frames. In fact the seat stays are identical to those used on the Secan 2.5. Made from 4130 steel the stays are 14mm in diameter and not tapered. We now heat treat the seat stays on the Faran 2.5 to add extra strength. The wall thickness of the tube is 0.8mm. The majority of seat stays [on steel bikes] are 16mm in diameter and taper down to approximately 11-12mm by the time they reach the dropout. This is largely a hangover from when there were limited dropouts on the market and they were designed to accept a certain sized tube. The wall thickness is still sufficient to cope with large loads if using a rack.

As an aside [and more relevant to the Faran] many dedicated touring bikes use 16mm or even 19mm seat stays to increase torsional stiffness when using large loaded panniers at both the front and the rear. In our view a dedicated world touring bike is as niche as something like a crit bike. How often is it being ridden with full world touring set up? So; the priority here is to focus on ride quality, so that for commuting, long rides such as audax/ randonneuring, or bike-packing weekends in the hills, it feels like a performance bike. Especially as we see a trend towards front loading combined with bike packing gear we've kept the frame focused on ride quality. Of course you can run a front (Faran only) and rear rack without any issue, and it will feel great. But if you are carrying the world on your bike it needs to be very stiff and overbuilt.

### SIZE 61R & 61T

### 16mm 4130 Seat Stays - Custom Shaped

4130 heat treated - 16mm - 0.8mm wall.

On the 61's we use 16mm seat stays.







**4130**  
**CHROMOLY**

**19mm 4130 Custom Formed Chain Stays**  
4130 heat treated - 19mm - 0.8mm.

As with the seat stays, the Secan 2.5 and Faran 2.5 share the exact same chainstays, utilizing the same tooling and forming dies. Chainstay lengths are identical as are the clearances for tyres and chainsets. For the v2.5 we are doing post forming heat treatment of the chainstays, which has allowed us to reduce the wall thickness from 0.95mm to 0.8mm; increasing compliance and saving 75g.

As with the Strael, the chain stays round at the BB shell to give max stiffness. On almost all other steel bikes, chainstays are vertically ovalized to make tyre and chainring clearance easier, it gives a perception of stiffness because 'side-on' they look large. The reality is they are big and stiff in the wrong axis. Pedalling forces are horizontal and ground forces are vertical so they should be wide in the horizontal plane and as narrow as possible vertically. These chainstays are difficult to design and to make but the effort pays off in ride quality.

There is a whopping 69mm clearance between the chainstays which allows for clearance of a 27.5 x 60mm tyre. Maximum 700x50mm (1x) or 700x47mm (2x). The frame is compatible with a max 50-34 double chainset or a 44T single ring. The chainstay length is 430mm, only 12mm longer than the Strael 3.0.





Clearance with a 700 x 43mm Panaracer Gravel King SK on a Hope 20Five rim.



The tyre measures up at 43.34mm.



Clearance with a 650 x 48mm Panaracer Gravel King Slick on a Hope Fortus rim.

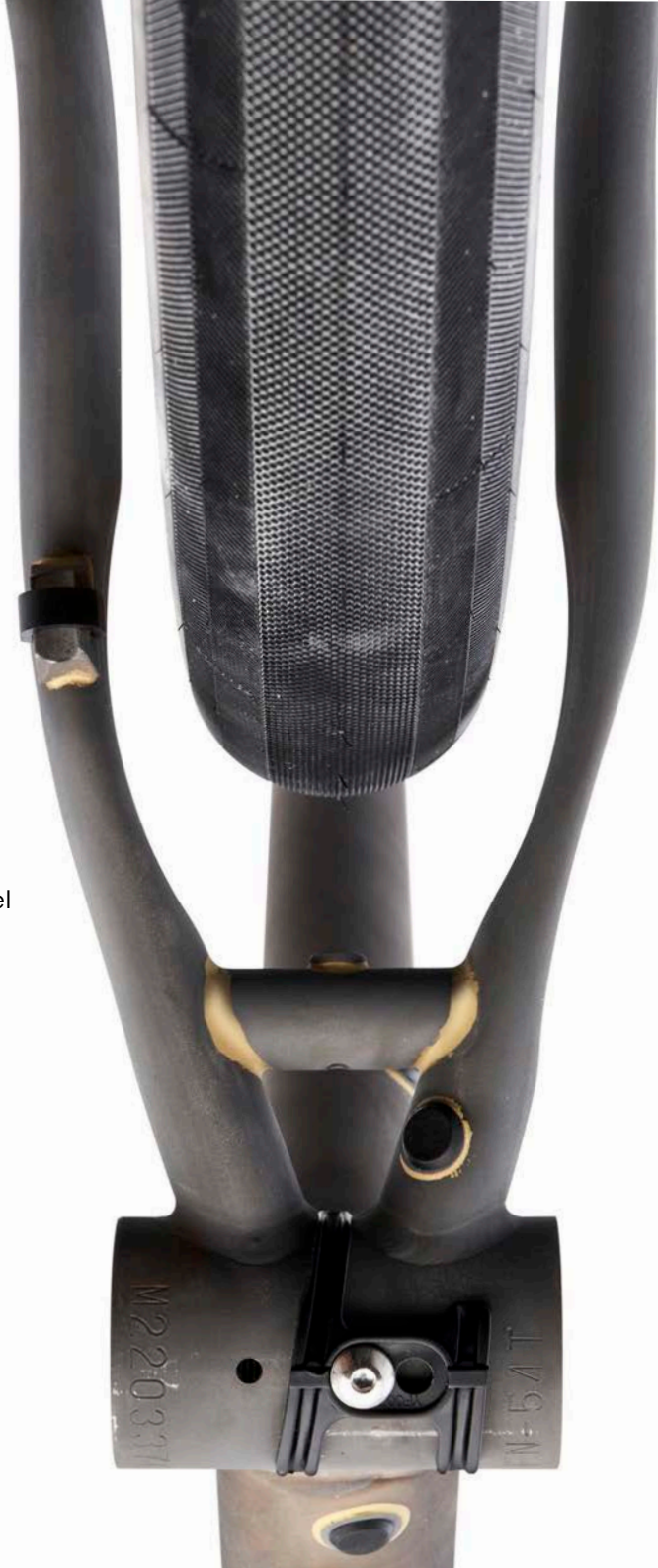

The tyre measures up at 50.51mm.





Clearance with a 650 x 2.2" Continental Race King on a Hope Fortus rim.



The tyre measures up at 55.3mm.





Clearance with a 650 x 2.2" Continental Trail King on a Hope Fortus rim.

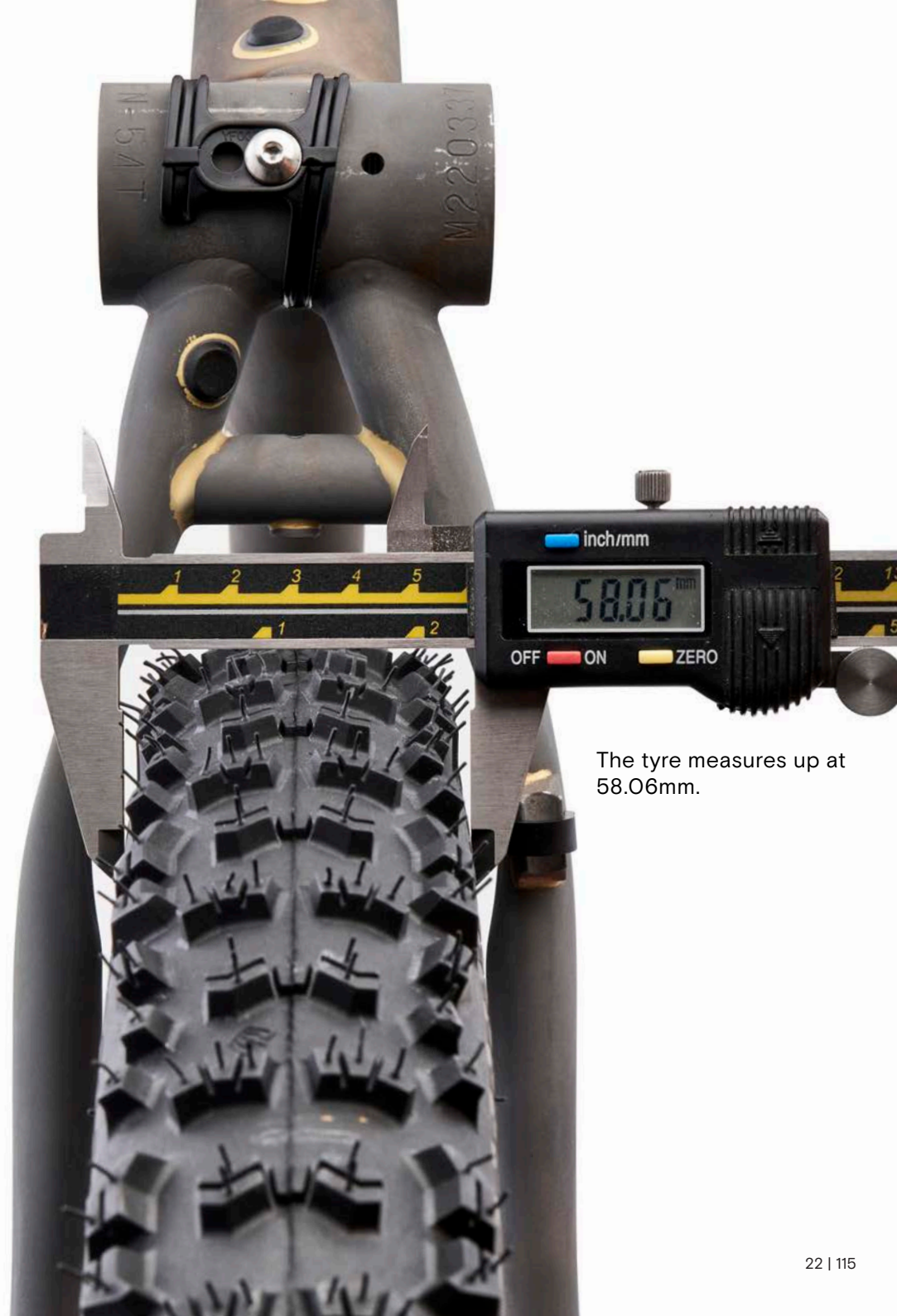

The tyre measures up at 58.06mm.

# BOTTLE MOUNTS



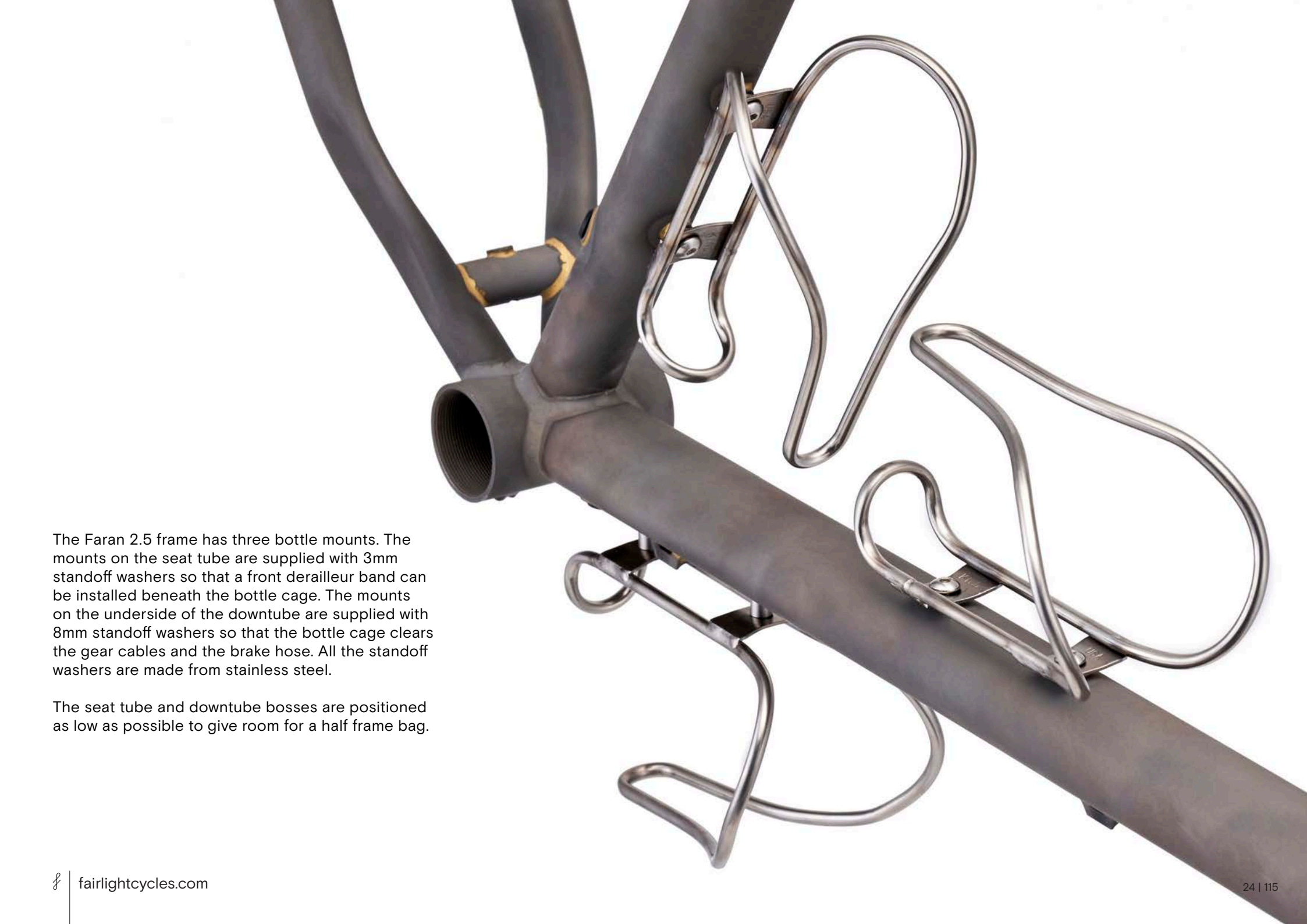

The Faran 2.5 frame has three bottle mounts. The mounts on the seat tube are supplied with 3mm standoff washers so that a front derailleur band can be installed beneath the bottle cage. The mounts on the underside of the downtube are supplied with 8mm standoff washers so that the bottle cage clears the gear cables and the brake hose. All the standoff washers are made from stainless steel.

The seat tube and downtube bosses are positioned as low as possible to give room for a half frame bag.





58 & 61 Frames: We realize that the low cage position on the seat tube might be a bit of a stretch for the tall folks; therefore on the 58 and 61 sizes there is a 3rd boss on the seat tube to mount the bottle cage higher if you wish.



The 2 x 8mm stainless stand off washers on the 3rd bottle mount ensure that the cage clears the brake hose and gear cables.



# DROPOUTS



# BENTLEY COMPONENTS



Mark Bentley is the man [and moustache] behind Bentley Components. He is an engineer for scientists by day and creator of beautiful bike parts by night. I started working with Mark 15 years ago when we both worked together at iconic British MTB and suspension brand Pace. He is an extremely talented designer, tool maker and CNC engineer. We are fortunate and grateful to be able to regularly collaborate with him on designs for Fairlight. He understands materials, their limits and specifically how to machine them. There is an enormous value in his hands-on experience. We are very proud to have the Bentley logo on our products, it truly is a mark of quality.

We are pleased to now be able to add the Mk II dropouts to the Faran 2.5! As with the Mk I all of the function is on display. If you saw the dropout and knew nothing about bikes, you would know straight away it was a technical part of the highest quality made for a specific functional purpose.

*Dom Thomas*



 x  MK II

### Fairlight x Bentley Mk II Dropouts

Visually there are some familiarities between the Mk I dropout and the new Mk II version. The main difference is that the dropouts are now completely modular; the axle housing and disc mount are made from one piece of aluminium, while on the drive side the axle housing and hanger are also a single piece. Both sides are completely removable and replaceable. The stainless washer plate detailing remains but the plates are now larger and have multiple functional purposes. Firstly and most importantly, the plates act as washers for the mechanical fixing of the inserts to the frame. Secondly they provide useful space for detailing and torque information, such as the axle torque (12Nm); now visible directly beside the axle head. Finally we've used the stainless plates to act as protectors for the mudguard and rack eyelet. The eyelets are a common place for paint to chip when fitting mudguards and/or a rack.

The steel parts of the dropouts are 'fillet brazed' together and the ends of the stays are ground and hand filed to give a seamless transition between the tubes and the plate; these techniques are usually only reserved for the custom world. The aluminum inserts are CNC machined (as opposed to the cheaper mass production method of 'casting') because the level of machining detail from CNC really says everything about how much care we put into our products. We are really proud to be able to show you what is beneath the paint.











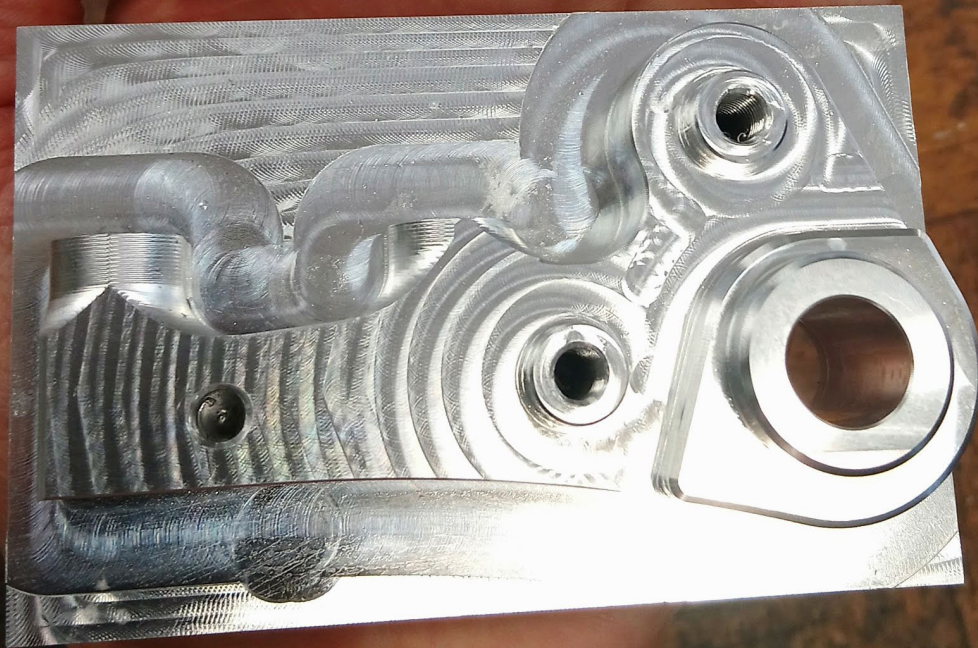
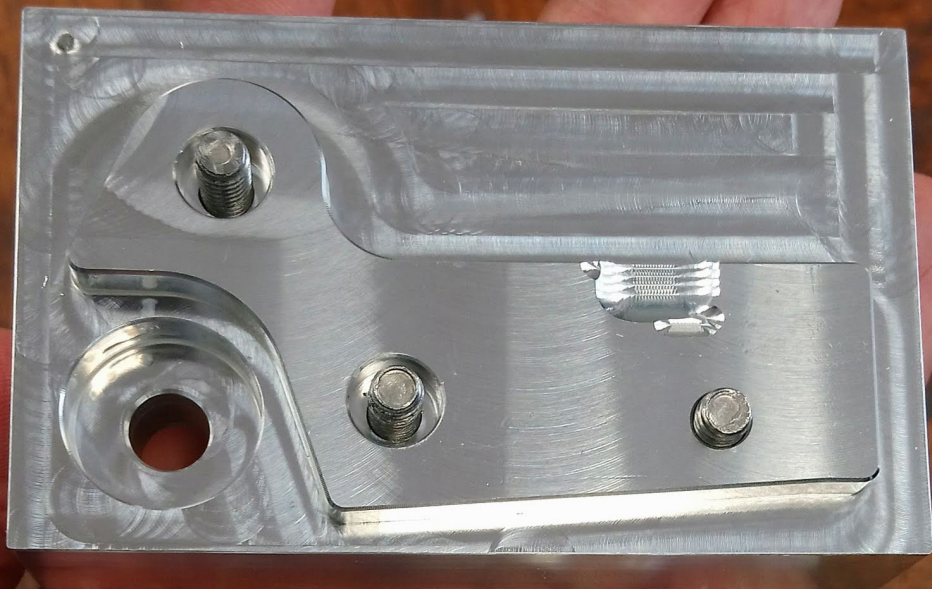









**Please note:** Threaded hole on the base of the disc side insert is for routing of a rear dynamo wire. More info later in the document.















Here you can see how the plate protects the paint for the mudguard and rack eyelets, providing a stainless face to attach the parts to.





# MODULAR CABLE GUIDES



## Modular Cable Guides

We use this system on all of our models. The cable guide is 3D printed which allows us to design and manufacture the intricately detailed part without requiring CNC machining or injection moulding. The guide is made from PA2200 Nylon which is strong and smooth. It has good chemical resistance and there is no strength degradation from UV exposure. The nylon has just the right level of malleability so that the surfaces fit together well with no risk of creaking. It is a great material for this application.

The part is beautifully simple and it only requires a single M5 threaded boss to secure it. It then utilizes an integrated pin which inserts into the Di2 hole to locate the part and stop it rotating. In the centre of the location pin is a 4mm hole which allows dynamo rear lights to be routed internally. A grub screw keeps the hole sealed when not in use. More on this feature further down in the lookbook.

There are specific guides for 1x and 2x. For using Di2 11 speed simply use the standard 6mm port below the guide. For Di2 12 speed and SRAM eTap AXS a 6mm rubber bung is provided to cover the Di2 hole.



2x guide

1x guide



Di2 11 speed set-up



Di2 12 speed & eTap AXS set-up







# FABRICATION DETAILS & WORKMANSHIP































# FARAN 2.5 FORK





## Faran Fork

A key part of the Faran concept is the use of a steel fork and a 'commitment to utility'. Compatibility with every rack and cage you can imagine and a high loading capacity. We use a unicrown fork design which in our opinion is the best way to make a steel fork for this type of bike; the simplest design and the strongest. Lugged forks with curved blades track the ground better than any other fork in our opinion and thus are very comfortable, but diving into a corner at high speed [especially when loaded] you'd rather be riding a unicrown fork. Additionally, they can be made lighter because of the increased structural strength of the welded legs. This is a thoroughly modern steel fork. Here are the key features:

Fork axle to crown length of 408mm. Fork offset of 60mm.

4130 28.6mm legs tapering to 18mm at the tips. Butted at 1.4/0.8 mm. The 1.4mm section is at the crown end which is the area of highest loading. A large 0.8mm section ensures good weight.

1.1/8" steerer tube. 350mm long.

100 x 12mm thru axle dropouts. Supplied with axle. Axle length is 124mm and thread pitch is M12x1.5.

Flat mount brake fitting. Compatible with 140/160mm rotors.

The dropouts have rack mount eyelets on the rear. Brazed on barrel mounts 30mm above the dropouts for installing a front pannier rack. We use barrel mounts versus traditional eyelets for extra strength with high rack loads. Also mid blade mounts for a pannier rack.

Barrel mounts for installing a randonneur type rack such as the Nitto M18. These are positioned at 100mm from the base of the crown.

Front and rear M5 mounts in the crown. Front for light mount or rando rack, rear for mudguards. We chose threaded bosses versus a hole as they can be adjusted independently and it makes for a lot easier fitting.

2 x 7.5mm holes for internal dynamo wire routing. Supplied with blanking grommets as well as specific grommets for SON and Supernova wires.

4 x bottle/adventure cages mounts on each leg. Positioned at 30 degrees. We use 4 mounts rather than 3 as the lengths, radius and widths of adventure cages varies a lot. This ensures all cages will fit. Also supplied with 6 x 3mm standoff spacers for extra adjustment.







Pictured with a 700x43mm  
Panaracer Gravel King SK 43mm  
on Hope 20Five rim. The tyre  
measures 43.3mm.



Pictured with a 27.5x2.2 Conti Race King on Hunt rim. Tyre measures 56.5mm.







Pictured with a SimWorks Obento rando rack and a pair of King cage 'many things' cages.





Pictured with a Nitto M18 rando rack and a pair of King cage 'many things' cages.



Pictured with a Nitto M18 rando rack and a Tubus Tara low-rider pannier rack.



A close-up photograph of a bicycle's rear drop seatpost and cage mount assembly. The seatpost is black and has a silver-colored cage mount attached to it. The cage mount is a curved metal piece that holds a seat. The assembly is mounted on a silver-colored metal frame. The background is a plain, light-colored surface.

The reason we have the cage mounts at 30 degrees is so that the cage mounts and low rider mount can be used simultaneously. 3mm stainless spacers are supplied to move the cage away from the installed rack on the low-rider mount.





The clip on the front of the leg keeps the dynamo wire well away from the tyre. Also by exiting the wire on the leg [as oppose to the base of the crown] it makes mudguard installation straightforward.











The clip on the front of the fork leg has a secondary purpose of positioning the Coaxial Junction Box for easy access. You can use this junction box to connect a charging device to the dynamo. This means you no longer have to use piggy back spades if you want to run a charger with the front lamp. Our fitted light sets come with the 'in-line' junction box as standard.









Pictured USB charger is the Sinewave Revolution. Tried, tested and recommended by a number of Fairlight riders, staff and ex-racers. We are now selling these with a pre-soldered co-axial fitting [here](#).

Male co-axial fitting soldered to the charger.



# REAR LIGHT ROUTING





### Rear Light with Mechanical Gears

As already mentioned in the cable guides section, our modular 1x and 2x cable guide are fully dynamo compatible. Simply remove the grub screw to reveal a 4mm hole for the wire to be routed through. The hole size is compatible with SON and Supernova wires.





### Rear Light with Di2 11 speed

If using Di2 11 speed then the dynamo wire needs to be routed through the M5 boss which is used to secure the cable guide.



### Rear Light with Di2 12 speed & SRAM eTap AXS

For Di2 12 speed & eTap put a blanking bolt into the M5 thread and use the 6mm Di2 hole for the dynamo wire. The frame is supplied with a rubber grommet for the wire.



### Dropout Mounted Lamp on Drive Side with Mechanical Gearing

In choosing locations to mount a rear dynamo light, our preference is to mount it on the dropout. Alternatively on the back of a rack or the back of the mudguards, but only if either is planned to be permanent. Rear lights mounted on the back of the seat tube or back of the seat post can be obstructed by saddle packs, especially on smaller frames. We like this dropout location as other parts can be fitted or removed without it affecting the light, apart from maybe having to space it out or change eyelet. The other benefit is that the light marks the edge of the bike and thus a driver is likely to give you more space.

If mounting the light on the drive side then there are 2 x 7.5mm ports to choose from. In this instance we've used the top one and shrink wrapped the wire to the derailleur housing.

Grommets are supplied with the frameset/bike for SON and Supernova wires.





### Dropout Mounted Lamp on Drive Side with Di2 Gearing

If using Di2 and a dynamo then we recommend using the port on the underside of the chainstay for the Di2 wire and using the port on the top for the dynamo.



**Dropout Mounted Lamp on Drive Side with SRAM  
eTap AXS gearing**

For eTap you can choose to use either port for the  
dynamo and use a blanking grommet in the other. We  
think the bottom port gives the neatest routing.



### Dropout Mounted Lamp on Disc Side

If you ride on the right hand side of the road (most of Europe and the US) then we recommend that you mount the light on the disc side. There is a port on the underside of the chainstay and we've added an M5 thread and clip into the bottom of the aluminium dropout insert. The result is super clean routing of the wire. The additional wire routing clip is supplied with the frameset/bike.







### Rear Rack Mounted Light

We recommend Tubus rear racks and you can route the wire directly into the rack leg. The additional wire routing clip is supplied with the frameset/bike.



Simply drill a 4mm hole into the rack for the wire to enter/exit.

Please note: This will almost certainly void the warranty of the rack but is a relatively common modification in the custom world. With the wall thickness of the rack tubing it won't cause an issue.





### Routing for Chainset Axles Larger Than 24mm - to Driveside

If using a chainset with an axle larger than 24mm (e.g. SRAM DUB-29mm, Praxis-30mm, Hope-30mm) then there is not enough room to route the dynamo wire through the BB shell. Therefore we have an additional 6mm dynamo port at the base of the downtube so the wire can enter/exit in front of the BB shell.

If mounting the rear light on the drive side the wire can enter/exit back into the chainstay via another 6mm port, A clip on the BB cable guide holds the wire and keeps it tidy.





### **Routing for Chainset Axles Larger than 24mm - to Disc Side**

Again exit/enter the wire at the port in front of the BB shell. Then join the lighting wire to the brake hose using short sections of heat shrink, between the hose guides. Follow the brake hose all the way to the dropout where the dynamo wire can then be routed away from the brake hose by using the clip on the bottom of the brake mount.

### **Mudguard Mounted Rear Light**

If mounting a light on the back of the mudguard then we recommend exiting the wire at the base of the downtube, going over the BB (using the clip) and into the mudguard at the chainstay bridge. We recommend using aluminum tape (or similar) to route the wire along the inside of the guard.



# GEOMETRY



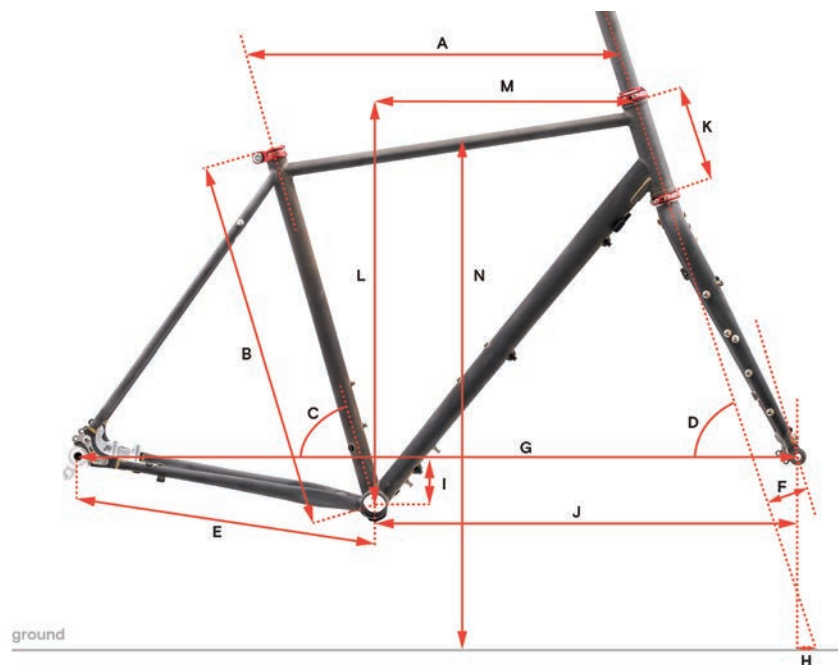

	Size	51R	51T	54R	54T	56R	56T	58R	58T	61R	61T
A	Top Tube Horizontal	535.9	534.7	547.5	548	565	563.7	583.5	582.8	597.3	597.9
B	Seat Tube (BB to top ST)	515	518	535	540	550	560	568	580	586	596
C	Seat Tube Angle	74	74	74	74	73.5	73.5	73	73	73	73.5
D	Head Tube Angle	71.5	71.5	72	72	72	72	72.5	72.5	72.5	72.5
E	Chainstay Length	430	430	430	430	430	430	430	430	430	430
F	Fork Rake	60	60	60	60	60	60	60	60	60	60
G	Wheelbase	1022.6	1022.6	1029.7	1030.8	1042.4	1042.4	1051.2	1051.2	1064.4	1072.1
H	Trail - 650 x 47 = 685mm	51.3	51.3	48.2	48.2	48.2	48.2	45.1	45.1	45.1	45.1
	Trail - 700 x 38 = 697mm	53.3	53.3	50.1	50.1	50.1	50.1	47	47	47	47
	Trail - 650 x 2.2" = 702mm	54.2	54.2	51	51	51	51	47.8	47.8	47.8	47.8
I	Bottom Bracket Drop	77	77	77	77	77	77	77	77	77	77
J	Front Center Distance	603.1	603.2	610.9	613	623.7	623.4	632.3	632	646.2	653.1
K	Head Tube Length	93	121	111	143	127	164	144	183	164	204
L	Stack	540.2	566.8	559.3	590	574.5	609.7	592.6	629.8	611.7	649.8
M	Reach	379.9	371.1	386.2	378	394.2	382.5	402.1	390.1	410.1	405
N	Standover Height (with 650x47 tyre)	765.5	780.2	784.7	802.3	798.9	821.3	816.1	840.4	834.2	858.7
	Fork Length - Axle to Crown	408	408	408	408	408	408	408	408	408	408

## The importance of Trail

So what is trail? Trail [or mechanical trail] is the relationship between head angle, fork offset and wheel/tyre diameter. As the illustration to the right shows, it is the horizontal distance between where the front wheel touches the ground (line directly vertical from axle centre) and where the steering axis (governed by head angle) would intersect the ground.

So how does trail effect handling? Well, trail is what makes a bike want to straighten out when you aren't giving a steering input. The more trail a bike has the more it wants to self centre and vice-versa. By adding a load to the fork it makes the bike want to self centre more. So by this logic a high trail bike with a front load will have a large self centering force and so it will take more input to make the bike turn.

The other thing we need to take into account is 'pneumatic trail', which is the effect that a larger tyre contact patch (because of deformation under load) has on the stability of the bike. Effectively a larger tyre at lower pressure is more stable than a narrower tyre at higher pressure. An example of this is that a 700 x 28mm tyre has the same outer diameter as a 650 x 47mm tyre, so if both were used on the exact same frame, each at their recommended pressures, the mechanical trail number would be the same. However the 650 x 47mm tyre would feel more stable because of the larger contact patch, which represents an increase in pneumatic trail.

### low-mid trail

On the Faran 2.5 we use 'low-mid trail' to provide better handling with a front load and also fast 'road-like' handling when there is no load and large tyres (e.g. road plus - 650 x 47 or 700 x 38-45). Trail with a 650x47mm tyre is 45-48mm depending on the frame size. So by reducing the trail the stability is reduced, but then a front load is added to give a desired stability, or rather that it is 'not too stable' with a front load and still stable enough when unloaded.

Continues on next page...



The theory was that by reducing the trail by approx 10mm (depending on frame size) versus the Strael/Secan you end up with handling that is very similar to the Strael (because of the increased pneumatic trail on the Faran from the larger tyres) but less stable than the Secan (pneumatic trail approx the same assuming same sized tyres, but the Secan has greater mechanical trail).

The table below shows the mechanical trail comparison between Strael, Secan and Faran.

	54R	54T	56R	56T	58R	58T
<b>Strael - Trail with 700 x 28 tyre - diameter 685mm</b>	60.7	60.7	54.4	57.5	54.4	57.5
<b>Secan - Trail with 650 x 47 tyre - diameter 685mm</b>	65.1	61.9	58.7	58.7	55.6	55.6
<b>Faran - Trail with 650 x 47 tyre - diameter 685mm</b>	48.2	48.2	48.2	48.2	45.1	45.1

If you then add a front load to the Faran the stability increases and it becomes more like a Secan without a load. It depends on the size of the load of course.

So in summary, unloaded with 650 x 47 or 700 x 38-44 (.ish) tyres the Faran feels fast and agile, like a Strael. With a front load added the stability increases and it feels more like a Secan. Perfect for fast commutes on variable road surfaces, or weekend tours with a medium front load such as a rando/pizza bag and two fork packs.

*“This is absolutely where this bike shines. When first setting out all loaded up, it almost felt like a self-driving vehicle. The Faran 2.0 magically retained its quick acceleration, but I could really perceive how the additional weight up front balanced the otherwise fast steering to give it an incredibly fluid and cruise-control-like feel when pedaling up and down gravel loads. I was delighted at how good it felt.” - Logan Watts - Editor - Bikepacking.com*

**BIKEPACKING**  
.COM



# WEIGHTS



## Faran 2.5 - Frameset

### Painted frame without bolts, rear axle & dropout inserts:

54T frame - 1,968g

56T frame - 1,990g

58T frame - 2,015g

Bolts, rear axle and dropout inserts = 208g

### Faran Fork:

1205g with paint but without axle or bolts.

Bolts, axle & grommets = 77g



## Faran 2.5 - Full build examples

54T GRX800 1x, 700c Hope FIVE20 RS4 wheels with Gravel King SK tyres - 10.48 Kg

54T GRX800 1x, 650B Hunt Adventure Carbon wheels with Gravel King Slick tyres - 10.11 Kg

51T GRX800 2 x, 650B custom Hope Fortus 23W Pro4 & SON dynamo wheels. Full lighting set up, Conti Race King 2.2" tyres - 11.21Kg

58R GRX600 1x, 700c Hope FIVE20 RS4 wheels with Gravel King SK tyres - 10.92Kg



**INCLUDED IN  
THE BOX**



# FARAN 2.5 FRAME



**Please Note:**  
The frameset is supplied with grommets for both SON and Supernova wiring.

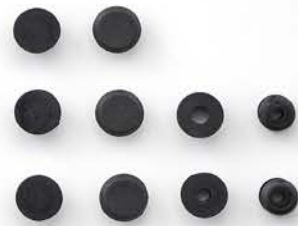

A



B



C



D



E

**Please Note:**  
The frameset is only supplied with either: A - 1x guide, B - 2x guide, C - Di2 11 speed set, D - AXS eTap set, E - Di2 12 speed set.

# FARAN FORK



**Please Note:**  
The frameset is supplied with grommets for both SON and Supernova wiring.

# FARAN PATTERN



## Faran Pattern

Quite often we get asked about the top tube pattern on the Faran and whether it means anything. Last year, we ran a story on instagram outlining the concept and creative process of the decals. A lot of you liked it, so we figured it was worth including in the design notes.

As for the engineering and industrial design, we also put a lot of thought into our graphics. I have a pretty simple rule that if you don't go through a process of thoughtful consideration then usually the object wont look designed. Here is a brief run through of how we created the pattern for the Faran.

A special thank you to my brother Patrick Thomas for all his time and help collaborating on these. Never have two siblings talked lines and dots so much.

*Dom Thomas*







### **Faran 1.0 - Anni Albers Inspired**

The pattern on the original Faran (2016) was based on the modernist textile designs of Anni Albers. She was a female student at the radical Bauhaus in Germany. She blurred the line between craft and art with her contemporary textile patterns.

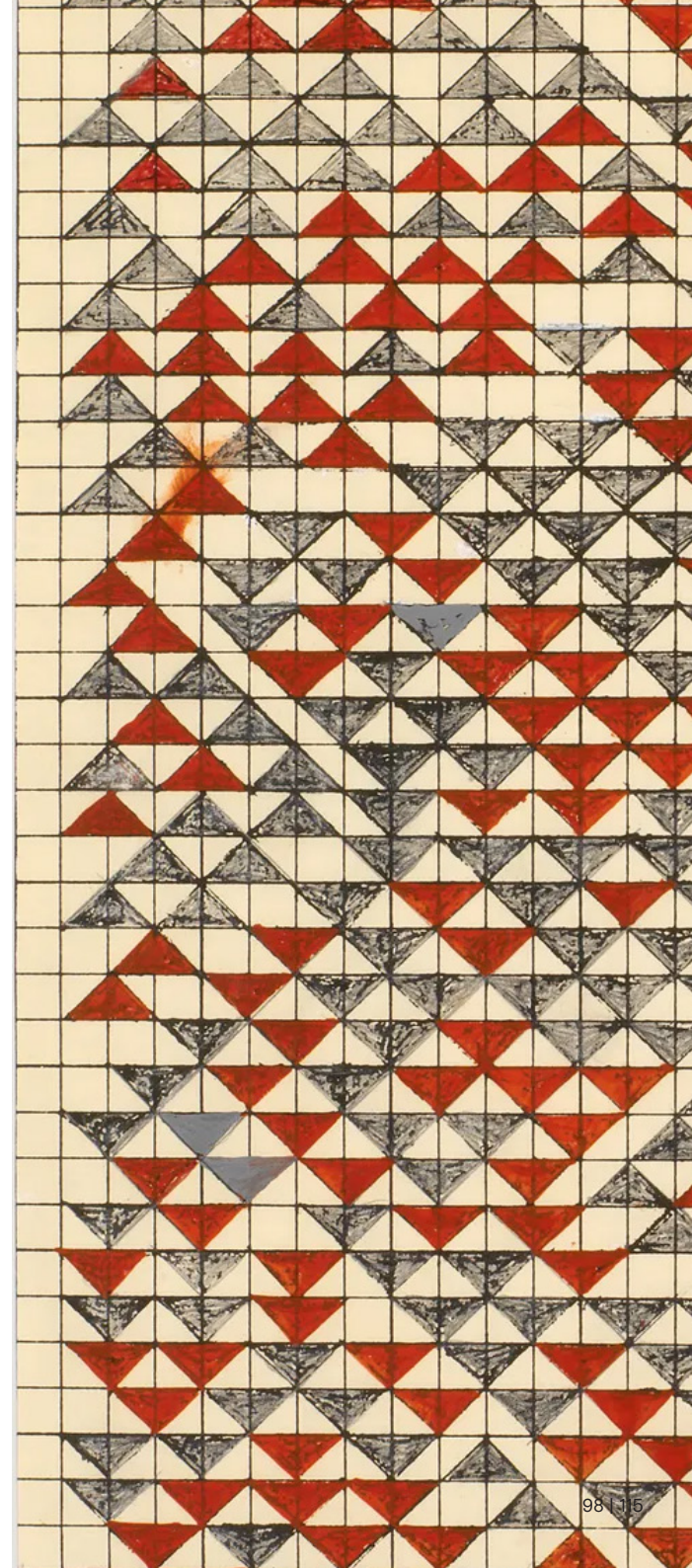



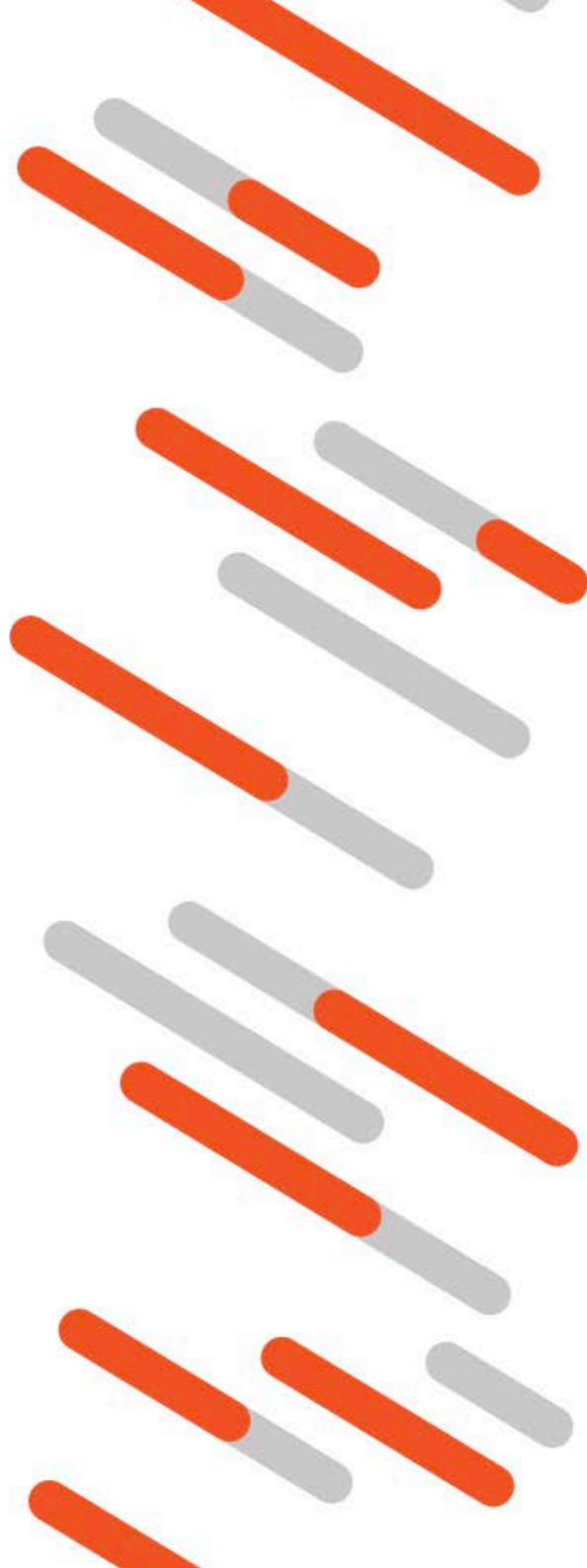

### **Faran & Secan Family**

The Faran 2.0/2.5 and the Secan 2.0/2.5 are in the same family of products and share many of the same features, so we wanted to carry across an element of the Secan pattern design so it felt familiar.

The merging lines on the Secan were designed to represent the transition between road and off-road.



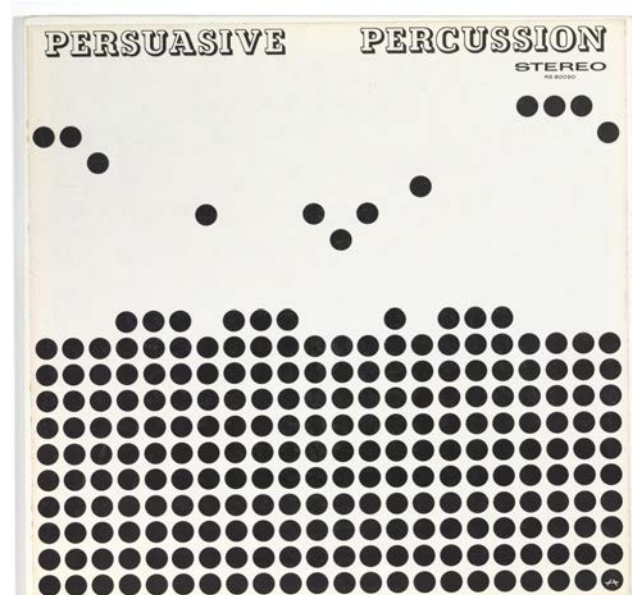
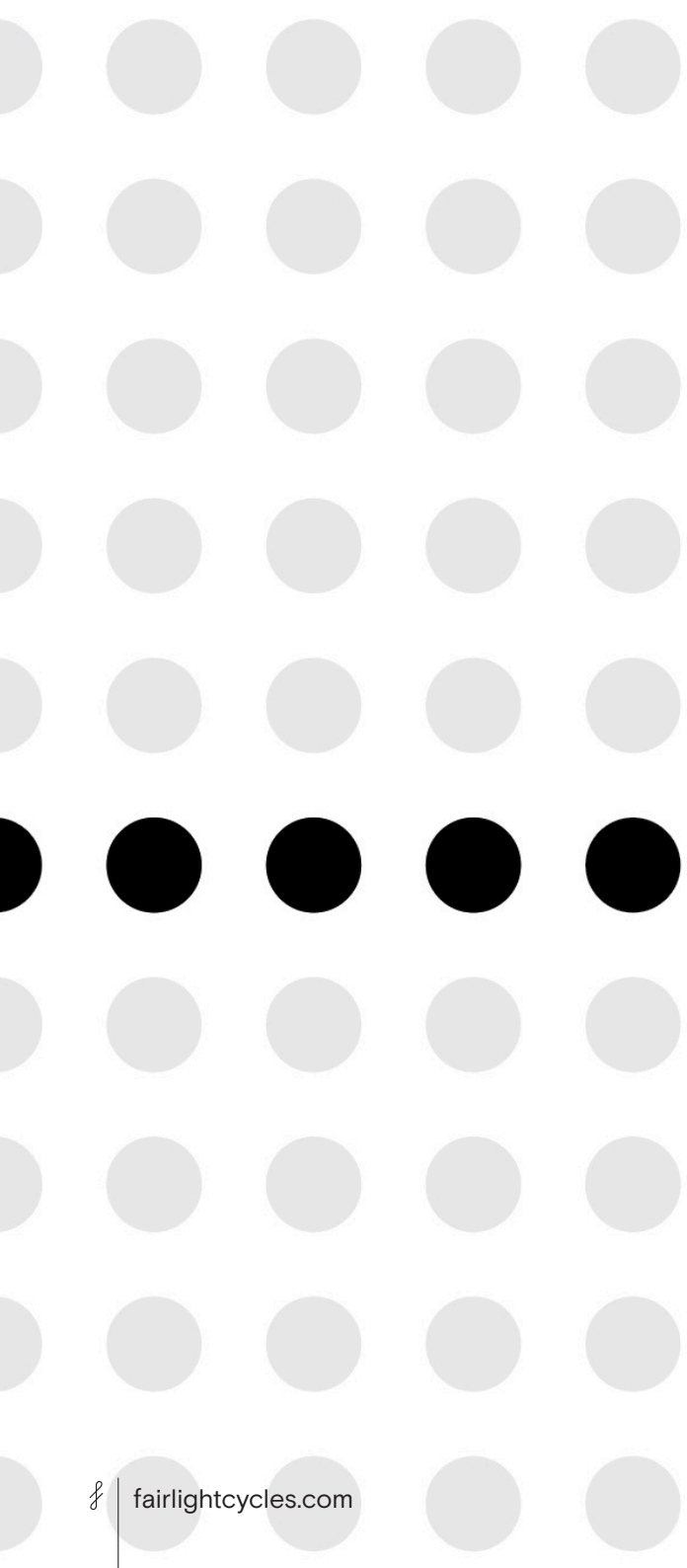

### Josef Albers - Dots

As a starting point for the Faran 2.0/2.5 graphics we looked at the work of Anni Albers husband Josef Albers. Specifically we looked at his use of dots.

So we decided to create a pattern using lines & dots, that would create a link to both the original Faran and the Secan. With those simple restrictions in place it allowed us to start focussing on the form.

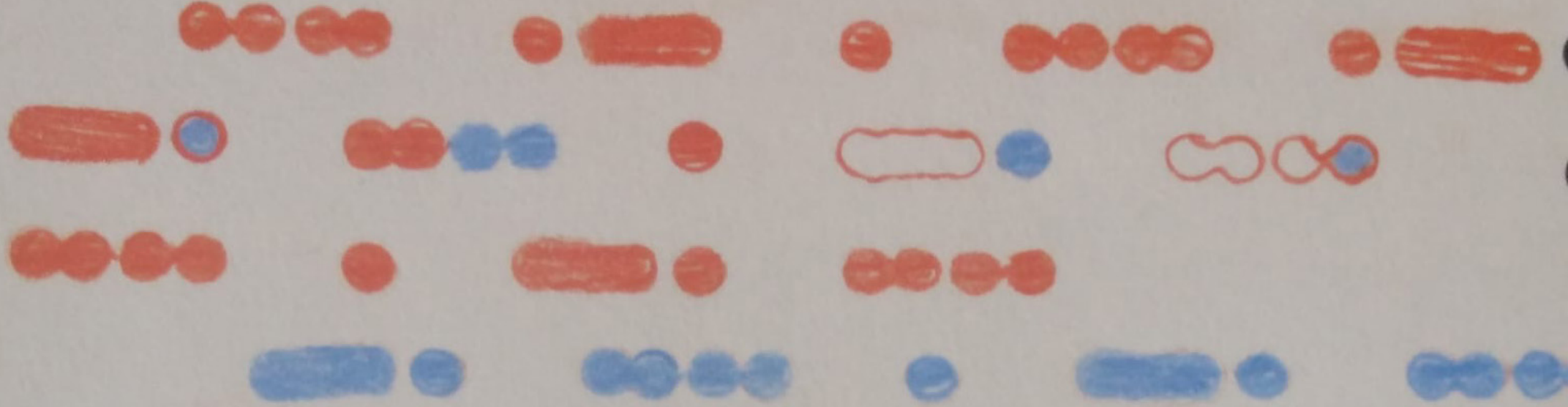

## Lines and Dots

Experimenting with lines and dots.  
Playing around with the form, evolving  
ideas.

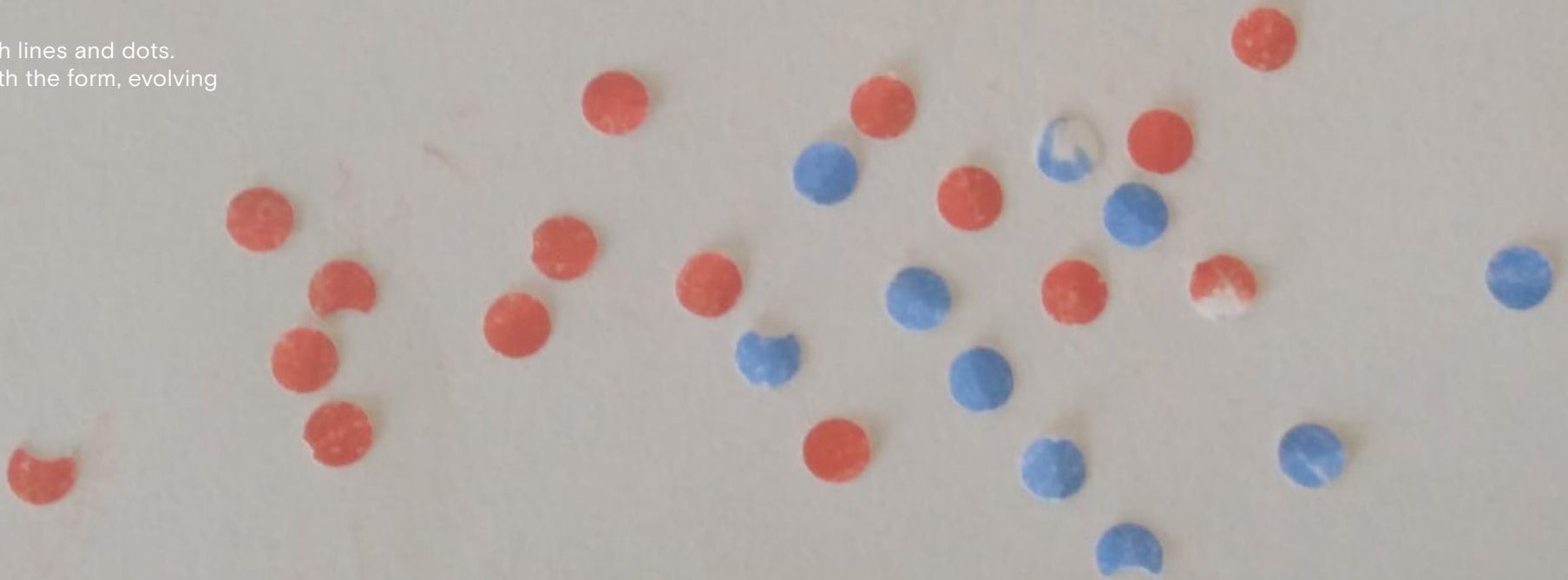

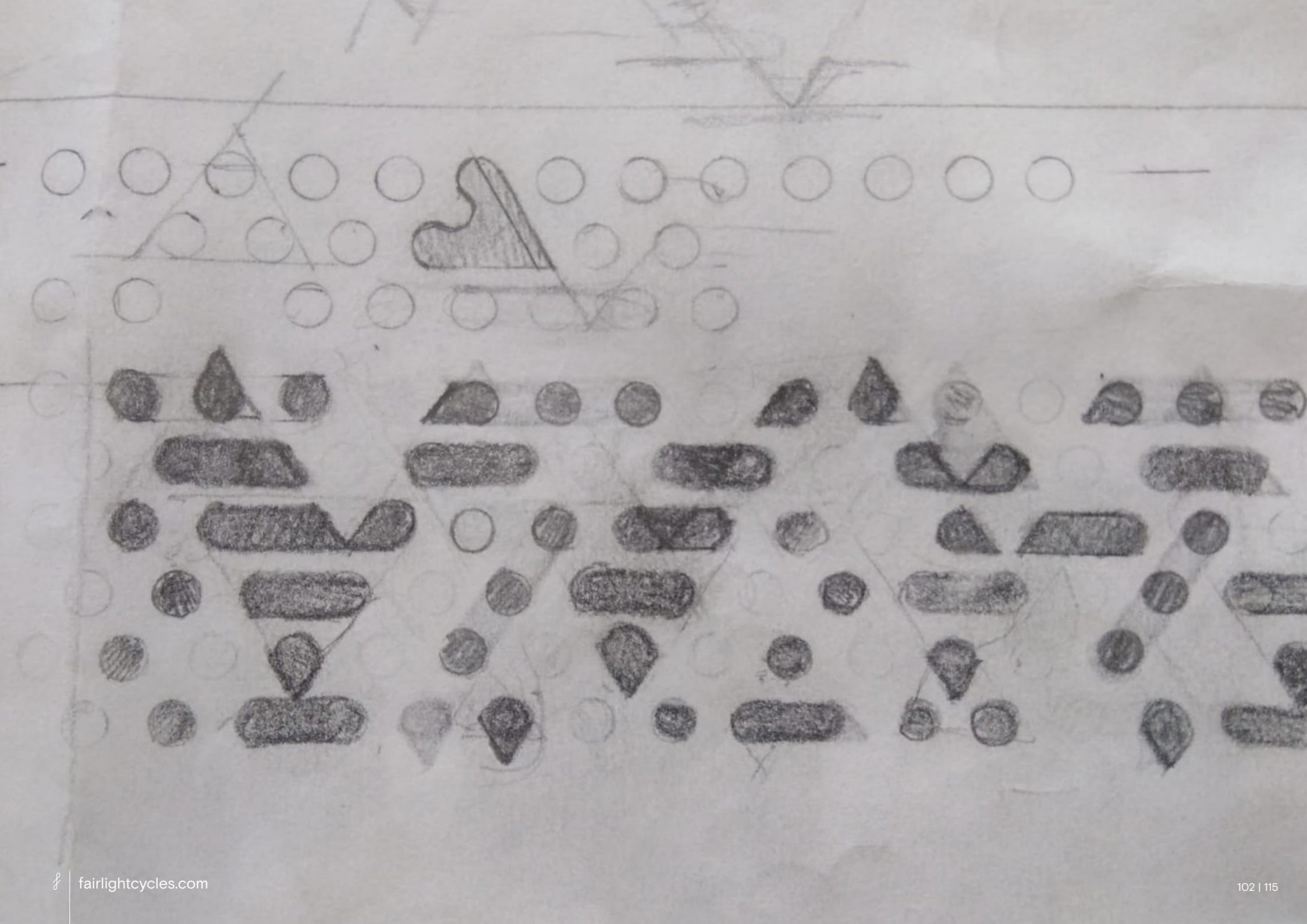





## Morse

The idea started to feel like something familiar. Line and dots; Morse code! This is how Faran looks.

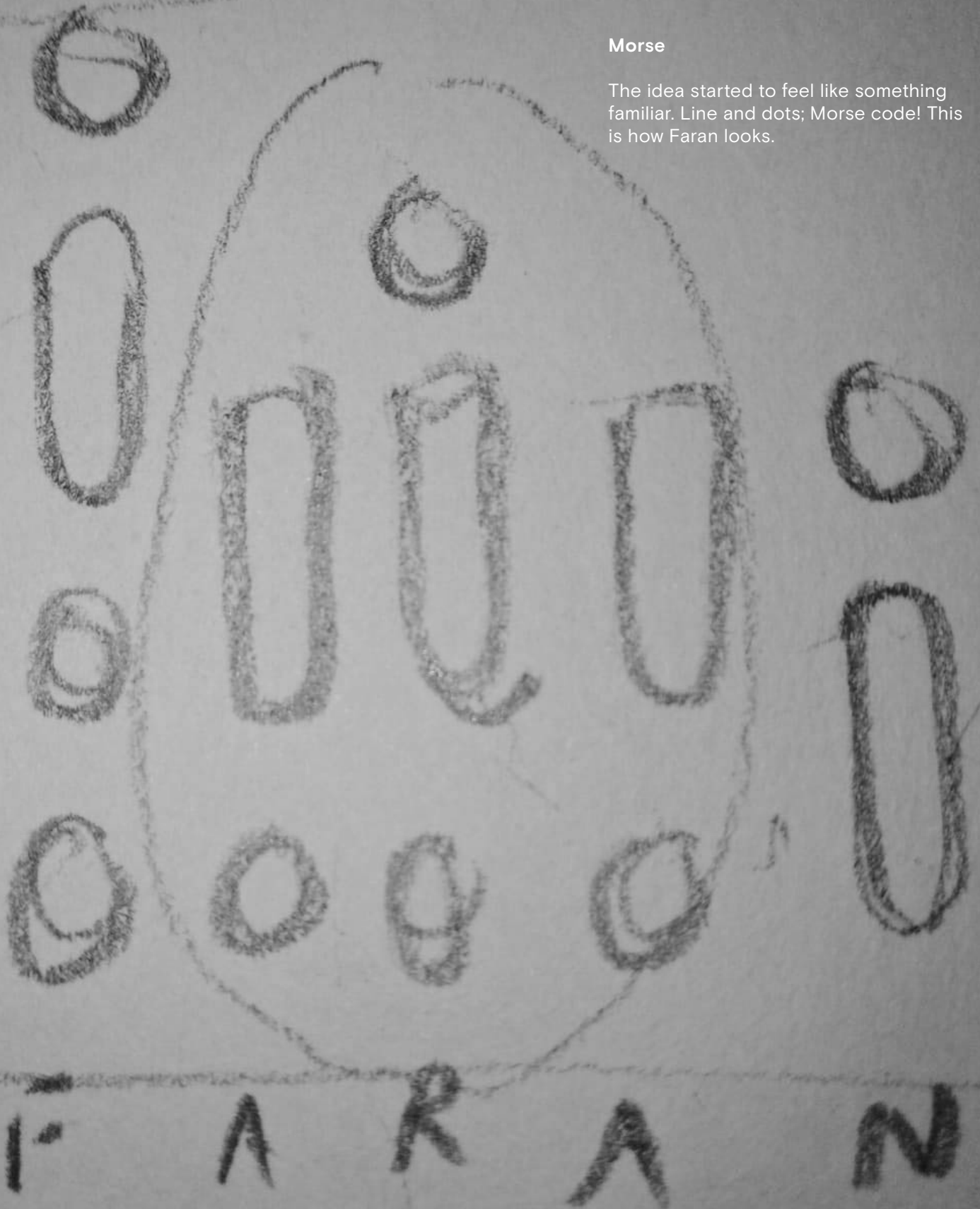

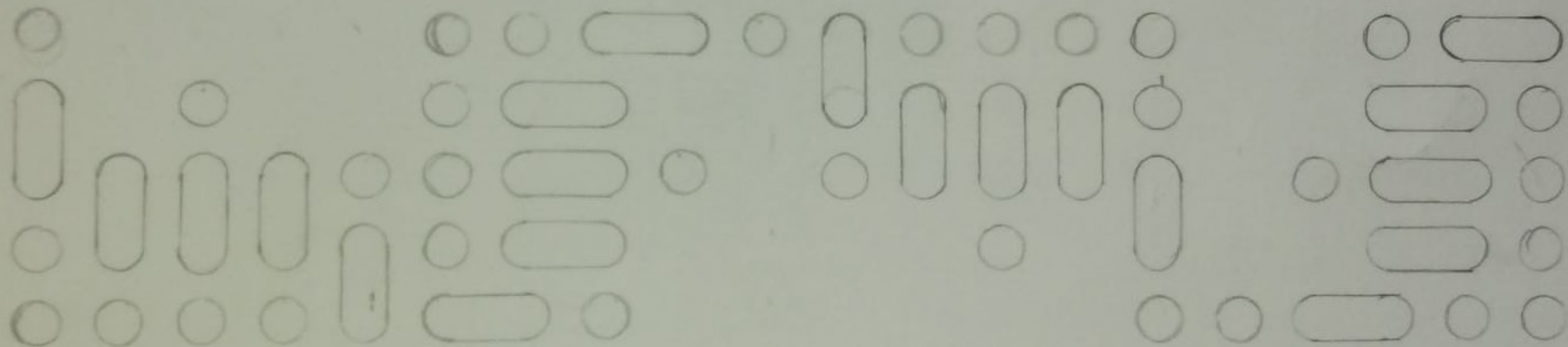

### Rotation

We amended the Farnam code pattern to make it square. This involved adding a dot. Now it was square we could rotate the pattern to create a repeating sequence.



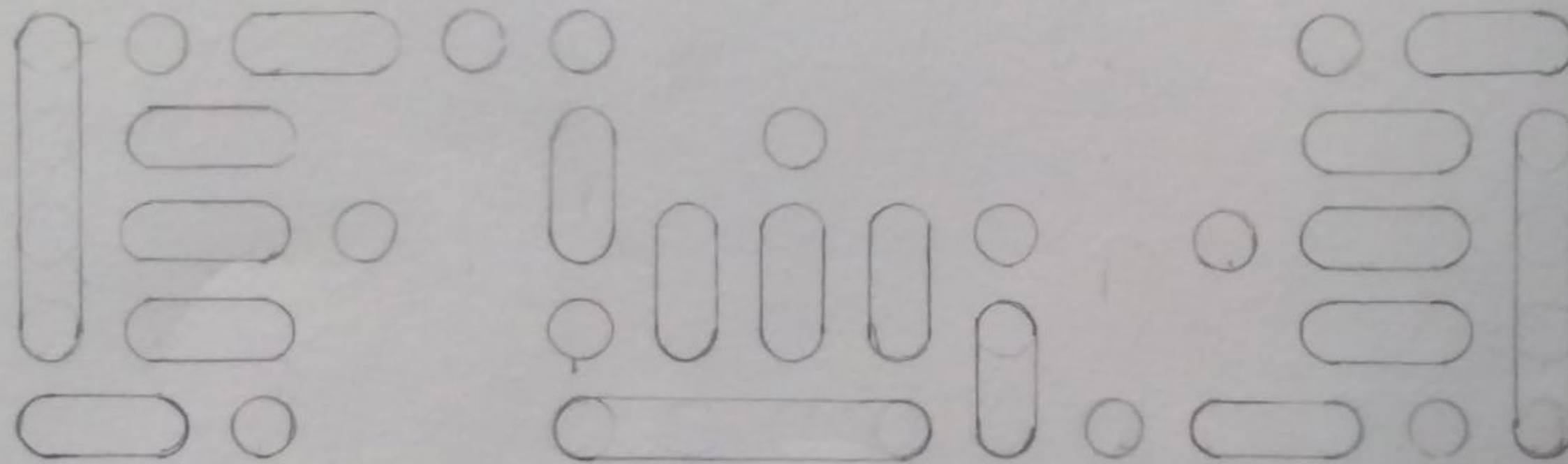

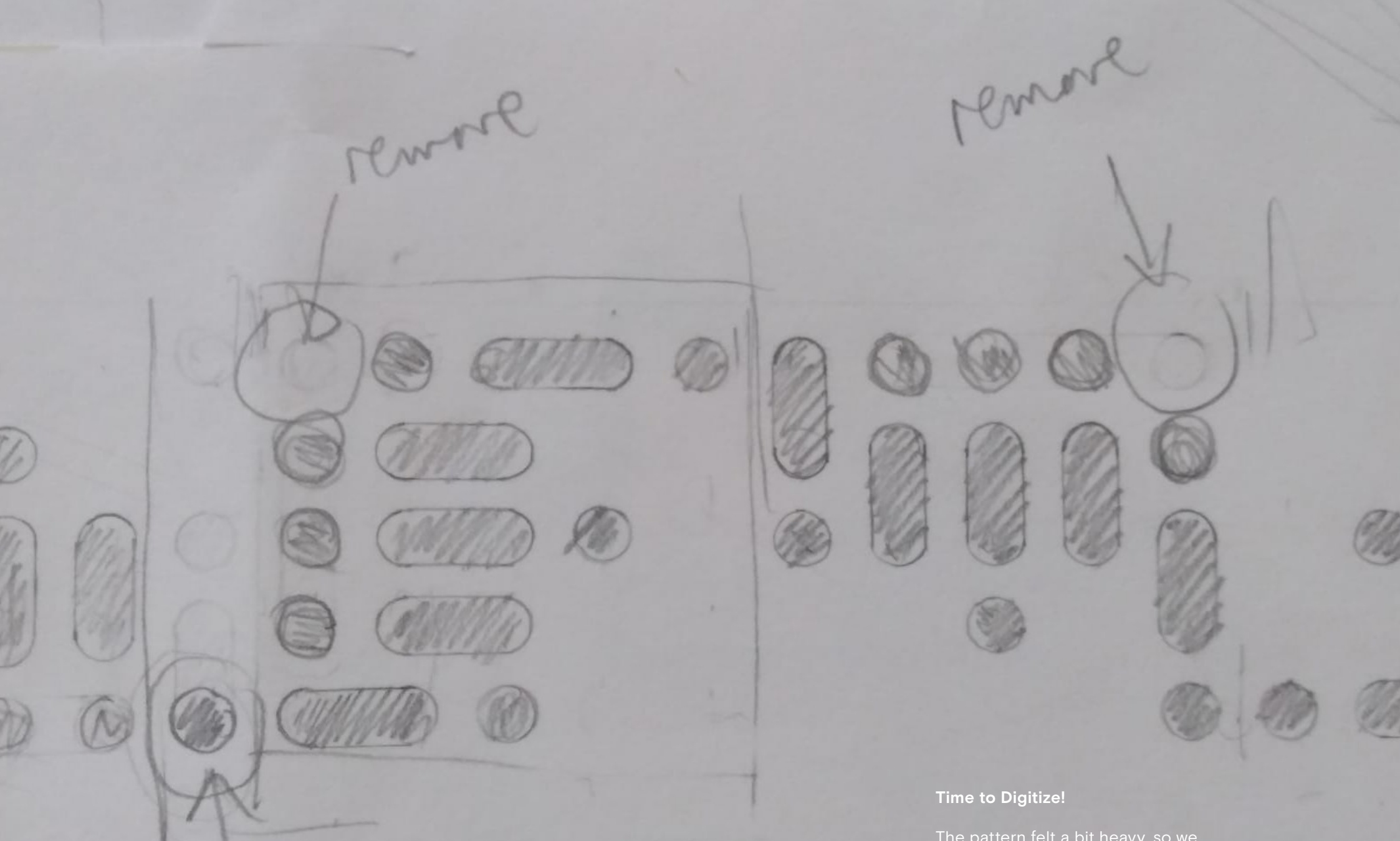

add on Sequence 1

**Time to Digitize!**

The pattern felt a bit heavy, so we started removing dots. At this point it was time to digitize things so we could edit it more easily.

## Scan

A quick scan and we overlaid the pattern in Adobe Creative Suite.

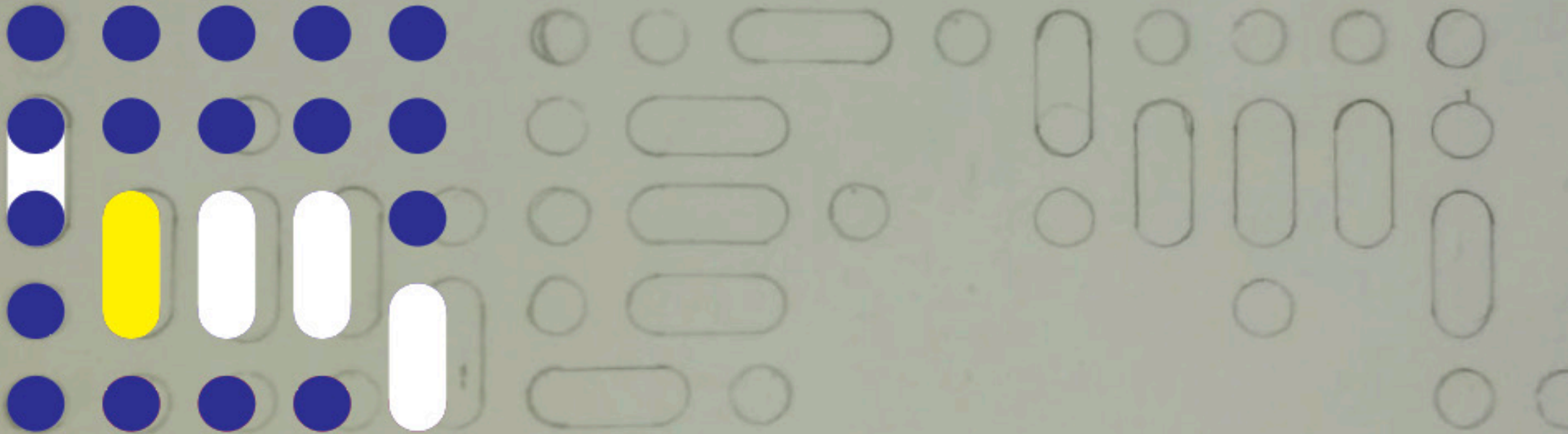



## Grid

A grid was formed where we could quickly and easily play with the design.

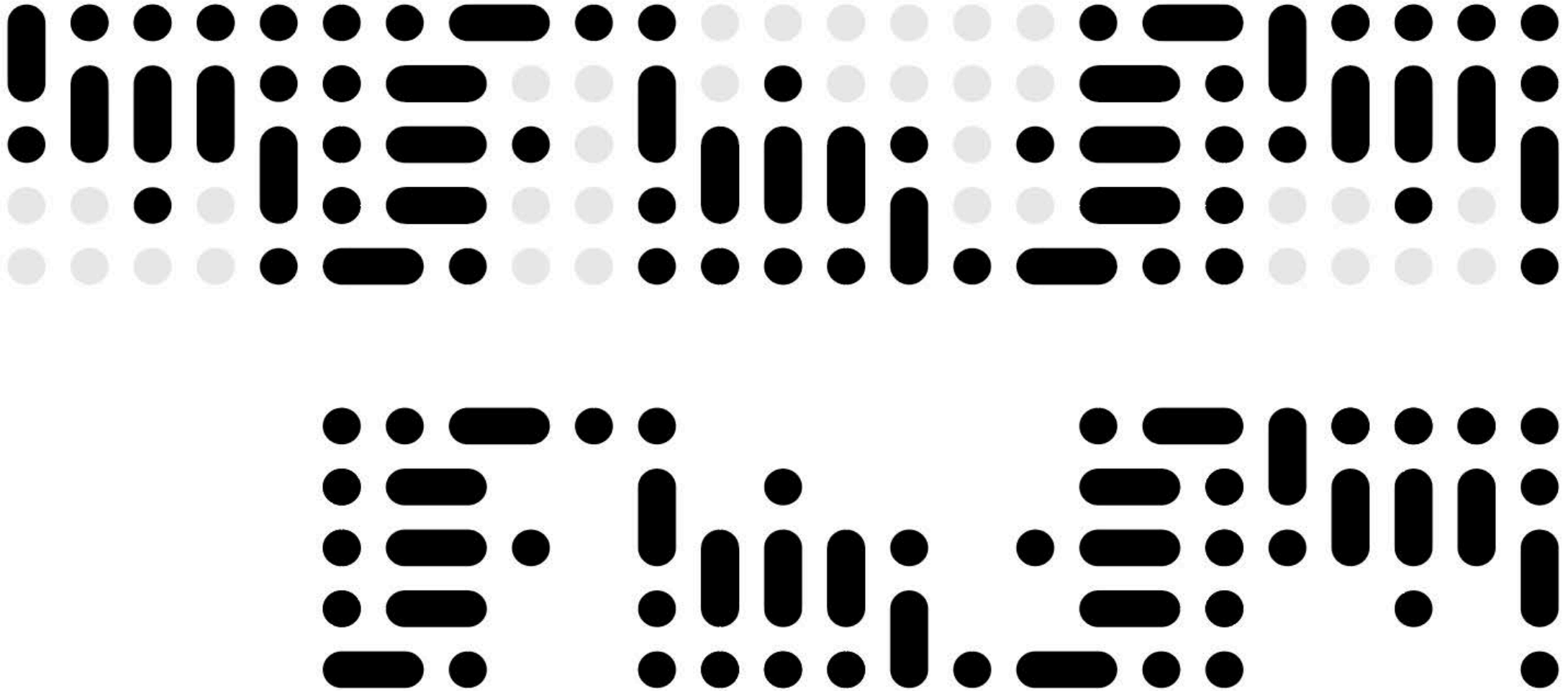



### Adding Colour

As with the Secan pattern the plan was always to use two colours in the pattern. It disrupts the form and makes it feel more random and I suppose, abstract.

### Scale

At a certain point in the design, it becomes about scale. While a computer is a great tool, you don't get a sense of scale on the screen. So we use good old acetate sheet to get the sizing right based on how your eyes see it on the tube.





**Final Decal**

The final pattern. We added a linking dot and dash to the Reynolds 631 down tube decal.





Anyway folks, that is how and why it looks like it looks!

**FARAN IS RANDONNEUR.**  
**FARAN IS ADVENTURE.**  
**FARAN IS COMMUTER.**  
**FARAN IS TOURER.**  
**FARAN IS GRAVEL.**  
**FARAN IS UTILITY.**  
**FARAN IS VERSATILITY.**





# FIT FUNCTION FORM

[mail@fairlightcycles.com](mailto:mail@fairlightcycles.com)

 **FAIRLIGHT**